

GMSTBVA 2,5/ 8-G-7,62

Order No.: 1766835

The figure shows a 10-position version of the product

<http://eshop.phoenixcontact.de/phoenix/treeViewClick.do?UID=1766835>Header, nominal current: 12 A, rated voltage: 400 V, pitch: 7.62 mm,
no. of positions: 8, mounting: Soldering

Commercial data

EAN	4017918032852
Pack	50 Pcs.
Customs tariff	85366990
Weight/Piece	0.0049 KG
Catalog page information	Page 245 (CC-2007)

Product notes

WEEE/RoHS-compliant since:
01/01/2003

<http://www.download.phoenixcontact.com>
Please note that the data given here has been taken from the online catalog. For comprehensive information and data, please refer to the user documentation. The General Terms and Conditions of Use apply to Internet downloads.

Technical data

Dimensions / positions

Pitch	7.62 mm
Dimension a	53.34 mm
Number of positions	8
Pin dimensions	1 x 1 mm
Hole diameter	1.4 mm

Technical data

Insulating material group	I
Rated surge voltage (III/3)	6 kV
Rated surge voltage (III/2)	6 kV
Rated surge voltage (II/2)	6 kV
Rated voltage (III/2)	630 V
Rated voltage (II/2)	630 V
Connection in acc. with standard	EN-VDE
Nominal current I_N	12 A
Nominal voltage U_N	400 V
Maximum load current	12 A
Insulating material	PBT
Inflammability class acc. to UL 94	V0

Certificates / Approvals

Approval logo



CSA

Nominal voltage U_N	300 V
Nominal current I_N	10 A

CUL

Nominal voltage U_N	300 V
Nominal current I_N	10 A

UL

Nominal voltage U_N	300 V
Nominal current I_N	10 A
Certification	CB, CSA, CUL, GOST, UL, VDE-PZI

Accessories

Item	Designation	Description
Assembly		
1755477	MSTB-BL	Keying cap, for forming sections, plugs onto header pin, green insulating material
Marking		
0804549	SK 7,62/3,8:FORTL.ZAHLEN	Marker card, printed horizontally, self-adhesive, 10-section marker strip, 12 identical decades marked 1-10, 11-20 etc. up to 91-99, sufficient for 120 terminal blocks
Plug/Adapter		
1734401	CR-MSTB	Coding section, inserted into the recess in the header or the inverted plug, red insulating material

Additional products

Item	Designation	Description
General		
1806177	FRONT-GMSTB 2,5/ 8-ST-7,62	Plug component, nominal current: 12 A, rated voltage: 400 V, pitch: 7.62 mm, no. of positions: 8, type of connection: Screw connection
1828731	GIC 2,5/ 8-G-7,62	Header, nominal current: 12 A, rated voltage: 500 V, pitch: 7.62 mm, no. of positions: 8, mounting: Soldering
1828977	GICV 2,5/ 8-G-7,62	Header, nominal current: 12 A, rated voltage: 500 V, pitch: 7.62 mm, no. of positions: 8, mounting: Soldering
1767067	GMSTB 2,5/ 8-ST-7,62	Plug component, nominal current: 12 A, rated voltage: 400 V, pitch: 7.62 mm, no. of positions: 8, type of connection: Screw connection
1832581	GMVSTBR 2,5/ 8-ST-7,62	Plug component, nominal current: 12 A, rated voltage: 500 V, pitch: 7.62 mm, no. of positions: 8, type of connection: Screw connection
1832471	GMVSTBW 2,5/ 8-ST-7,62	Plug component, nominal current: 12 A, rated voltage: 500 V, pitch: 7.62 mm, no. of positions: 8, type of connection: Screw connection

Drawings

Drilling diagram

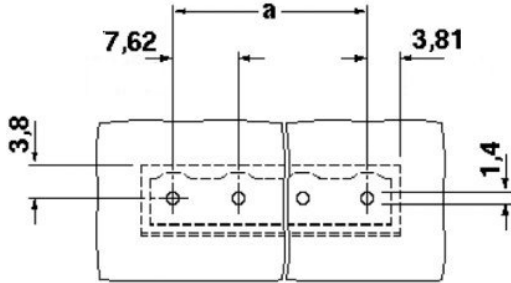

Dimensioned drawing

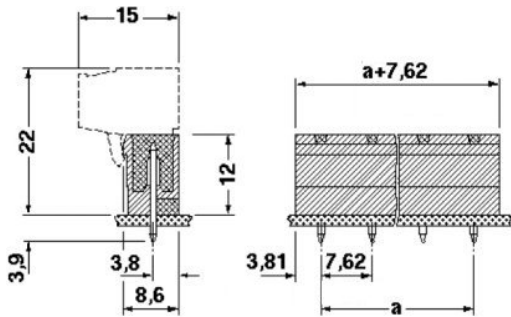

Address

PHOENIX CONTACT GmbH & Co. KG
Flachmarktstr. 8
32825 Blomberg, Germany
Phone +49 5235 3 00
Fax +49 5235 3 41200
<http://www.phoenixcontact.de>



© 2008 Phoenix Contact
Technical modifications reserved;